

ARTICULO: 2108

Válvula de mariposa tipo LUG

Butterfly valve LUG type

Características	Features
<ol style="list-style-type: none"> 1. Válvula de mariposa tipo Lug. 2. Cuerpo de Fundición Nodular EN-GJS-400 (GGG-40) para montaje entre bridas EN 1092 PN 10/16. 3. Elastómero de EPDM. 4. Disco de Acero Inoxidable 1.4408 (CF8M). 5. Brida montaje actuadores según ISO 5211. 6. Longitud entre caras según EN 558-1 Serie 20 (DIN 3202 K1). 7. Pintado con pintura Epoxi. 8. Máxima presión de trabajo: 16 bar (medidas DN50 a DN150) 10 bar (medidas DN200 a DN300) 9. Temperatura de trabajo -20°C +120 °C. 	<ol style="list-style-type: none"> 1. Butterfly valve Lug type. 2. Ductile Iron EN-GJS-400 (GGG-40) body allows installation between EN 1092 PN 10/16 flanges. 3. EPDM body seat. 4. Disc made of Stainless Steel 1.4408 (CF8M). 5. Actuator mounting plate according to ISO 5211. 6. Face to face according to EN 558-1 Series 20 (DIN 3202 K1). 7. Epoxy painted. 8. Maximum working pressure: 16 bar (sizes DN50 to DN150) 10 bar (sizes DN200 to DN300) 9. Working Temperature -20°C +120 °C.

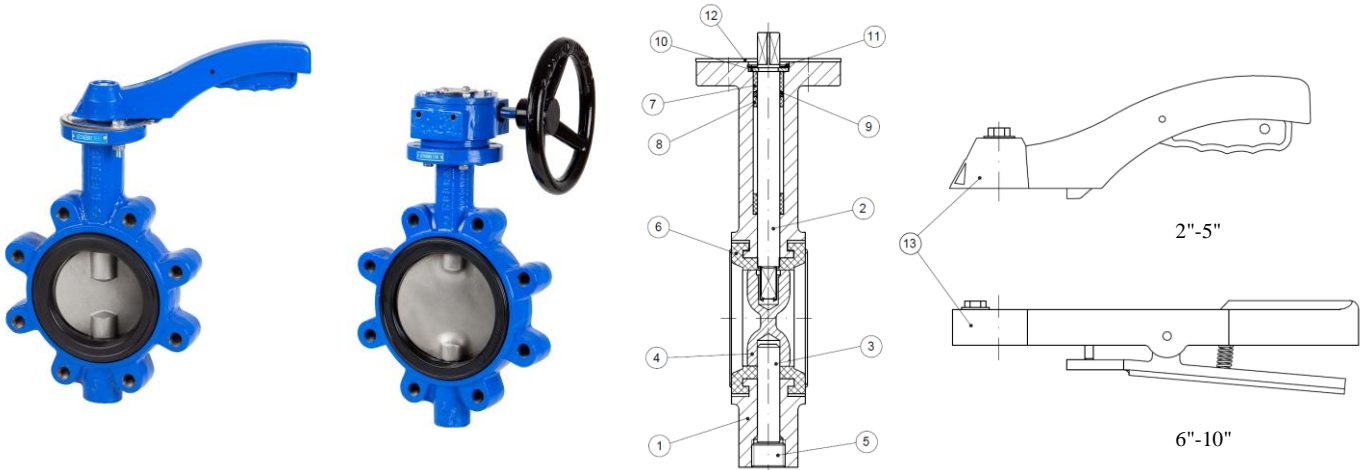

N.	Denominación / Name	Material	Acabado Superficial / Surface Treatment	Cód. Recambio Spare Part Code
1	Cuerpo / Body	Fundición nod. / Ductile Iron EN-GJS-400	Pintado Epoxi / Epoxy Painted	-----
2	Eje / Stem	Acero Inox. / Stainless Steel AISI 416	-----	-----
3	Pivote / Pivot	Acero Inox. / Stainless Steel AISI 416	-----	-----
4	Disco / Disc	Acero Inox. / Stainless Steel 1.4408	Granallado / Shot blasting	-----
5	Tapón / Plug	Acero Carbono / Carbon Steel	Cincado / Zinc Plated	-----
6*	Elastómero / Seat	EPDM	-----	E2109
7	Casquillo / Bush	PTFE + Grafito / Graphite	-----	-----
8	Casquillo / Bush	PTFE + Grafito / Graphite	-----	-----
9	Tórica / O' ring	NBR	-----	-----
10	Arandela / Washer	Acero Carbono / Carbon Steel	Cincado / Zinc Plated	-----
11	Seguro / Stop Ring	Acero Carbono / Carbon Steel	Cincado / Zinc Plated	-----
12	Placa dentada / Plate	Acero Carbono / Carbon Steel	Cincado / Zinc Plated	-----
13	Palanca / Handle	Aluminio 2"-5" o Fundición EN-GJL-200 6"-10" / Aluminium 2"-5" or Cast iron EN-GJL-200 6"-10"	Pintado Epoxi / Epoxy Painted	-----

* Piezas de recambio disponibles / Available spare parts

DIMENSIONES GENERALES / GENERAL DIMENSIONS

Ref	DN	L	Dimensiones / Dimensions (mm)					N x d	Peso / Weight (kg)
			A1	A2	D	P	J		
2108 09	50	43	240	79	90	216	****	4 x M16	4,200
2108 10	65	46	240	93	90	216	****	4 x M16	4,800
2108 11	80	46	245	103	90	216	****	8 x M16	6,000
2108 12	100	52	265	120	90	216	****	8 x M16	8,100
2108 13	125	56	290	133	90	216	****	8 x M16	9,800
2108 14	150	56	240	158	125	300	****	8 x M20	13,000
2108 16	200	60	280	180	125	300	****	8 x M20	17,500
2108 18	250	68	325	216	125	300	****	12 x M20	28,500
2108 20	300	78	351	251	150	290	240	12 x M20	49,600

*** Nota: la medida 12" (DN 300) operación mediante reductor manual

*** Note: size 12" (DN300) handling by gear operator

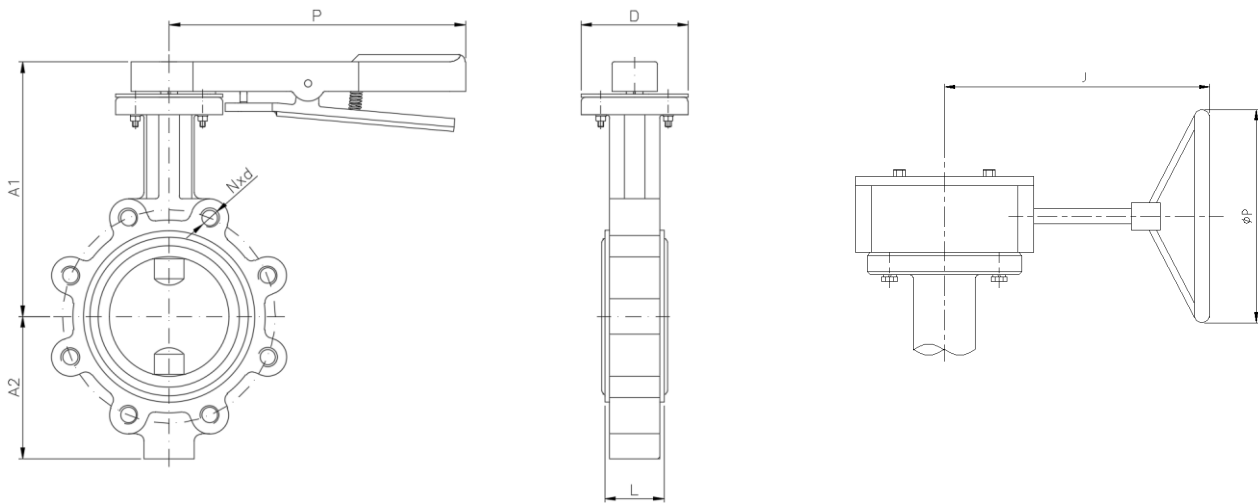

Dimensiones de brida superior / Top flange dimensions:

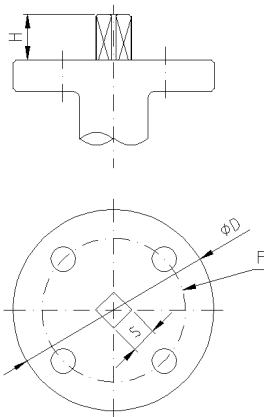

Dimensiones Brida Superior / Top Flange Dimensions						
Ref.	DN	F (ISO 5211)	S mm	D mm	H mm	Torque N·m
2108 09	50	F07	11	90	16	12
2108 10	65	F07	11	90	16	20
2108 11	80	F07	11	90	16	27
2108 12	100	F07	14	90	16	40
2108 13	125	F07	14	90	16	60
2108 14	150	F07 – F10	17	125	30	90
2108 16	200	F07 – F10	17	125	30	120
2108 18	250	F10	22	125	40	180
2108 20	300	F10 – F12	22	150	40	240

Pérdidas de Carga (Kv) según posición del disco / Head losses according to disc position:

DN	Posición del Disco (grados) / Disc Position (degrees)								
	90°	80°	70°	60°	50°	40°	30°	20°	10°
50	125	99	73	53	37	23	14	6	0,9
65	244	193	141	93	58	37	21	10	1,3
80	399	315	231	133	83	53	30	13	1,7
100	727	606	429	237	148	94	54	23	2,6
125	1190	991	670	370	232	147	85	37	4
150	1600	1334	887	490	306	195	112	48	5
200	2868	2458	1611	935	588	364	208	88	10
250	4697	3914	2550	1479	931	577	330	140	16
300	6987	5822	3800	2217	1379	869	480	203	23

VALORES DE Kv / Kv VALUES

Kv = Es la cantidad de metros cúbicos por hora (m³/h) que pasará a través de la válvula generando una pérdida de carga de 1 bar.

Kv = Flow rate of water in cubic meter per hour (m³/h) that will generate a pressure drop of 1 bar across the valve.

VALORES DE Cv / Cv VALUES

Cv = Es la cantidad de galones por minuto (gpm) que pasará a través de la válvula generando una pérdida de carga de 1 psi.

Cv = Flow rate of water (g.p.m.) which generates a pressure drop of 1 psi across the valve.

$$\boxed{Cv = 1,156 \cdot Kv}$$

Medidas de Precaución para instalación / Caution measures for Installation:

1. No instale la válvula en posición totalmente cerrada / *Do not assemble the butterfly valve in total closed position.*
2. Verifique el buen paralelismo de las bridas / *Check the good parallelism of the flanges.*
3. No coloque otras juntas entre las bridas / *Do not insert other gaskets between flange and valve.*

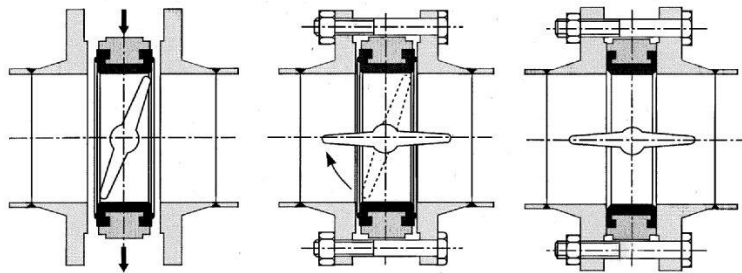

4. Si la válvula va ha ser instalada al final de la tubería, la presión máxima de trabajo es: / *If the valve is installed at the end of the pipe, the maximum working pressure is:*

DN50 a / to DN150 16 bar x 0.4 = 6,4 bar
DN200 a / to DN300 10 bar x 0.4 = 4,0 bar

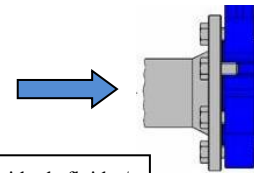

Sentido de fluido /
Flow direction

CURVA PRESIÓN TEMPERATURA / PRESSURE TEMPERATURE RATING

