

FVBC

Standard Cylinder



Specifications

Bore Size (mm)	32	40	50	63	80	100
Acting type	Double Acting					
Working medium	Clean Air(40 μ m filtration)					
Working pressure (MPa)	0.1~1.0					
Guaranteed pressure (MPa)	1.5					
Working temperature (°C)	-20~80(No freezing)					
Speed range (mm/s)	50~800					
Cushion type	Air Cushion					
Cushion stroke (mm)	27		30		36	
Mounting type	LB FA FB CA CB CR					
Port size ①	G1/8		G1/4		G3/8 G1/2	

① PT, NPT port size is optional.

How to Order?

Series No.	Cushion Type	Type No.	Bore	X	Stroke	Adjustable Stroke	Magnet No.	Seal Material	Mounting Type	Thread Type
FVB: Square type barrel	C: Air cushion	32	25	10	Blank: No magnet S: With magnet			Blank: TPU seal	Blank: No CA CB IJ CR YJ LB YCJ FA BJ FB FD	Blank: G P: PT T: NPT
		40	50	20						
		50	75	30						
		63	...	40						
		80		50						
	Blank: Basic type	100		75						
	D: Double shaft type			100						
	J: Double shaft and adjustable stroke type									

Order Example:

FVBC series, double shaft air cylinder, Bore 40mm, stroke 50mm, with magnet, TPU seal material, CA mounting accessory, NPT thread.

ERP code is: FVBCD 40X50-S-CA-T

Note: If cylinder with several different mounting accessories, please use this sequential coding: CA/CB/CR/LB/FA/FB/IJ/YJ/BJ/FD

Optional Accessories

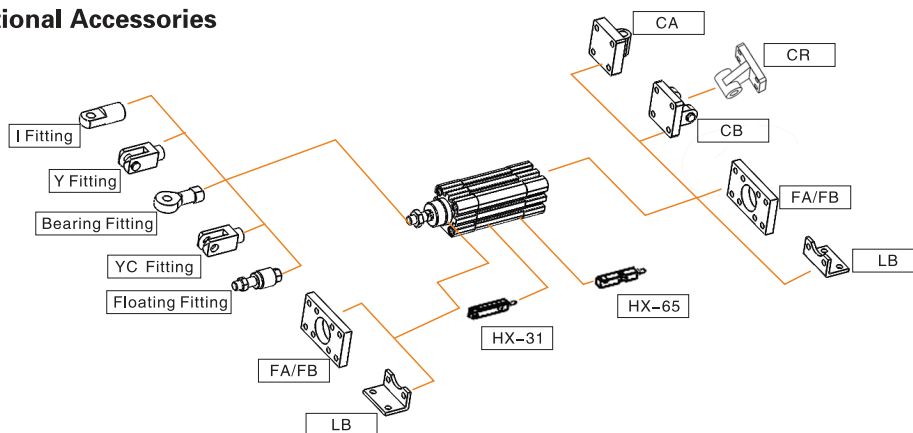

Stroke

Bore (mm)	Standard Stroke (mm)	Max. Stroke (mm)
32	25 50 75 80 100 125 150 160 175 200 250 300 350 400 450 500	1900
40	25 50 75 80 100 125 150 160 175 200 250 300 350 400 450 500 600 700 800	1900
50~100	25 50 75 80 100 125 150 160 175 200 250 300 350 400 450 500 600 700 800 900 1000	1900

FVBC Series ISO15552 Standard Cylinder



Internal Structure

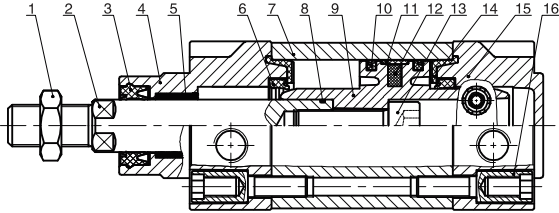

NO.	Part Name	Material
1	Nut	Carbon steel
2	Piston rod	S45C hard chrome carbon steel
3	Piston rod seal	TPU
4	Head cover	Aluminum alloy
5	Self lubricating bearing	Bronze powder
6	Cushion seal	TPU
7	Barrel	Aluminum alloy
8	O-ring	NBR
9	Piston	Aluminum alloy
10	Piston seal	TPU
11	Wear ring	PTFE
12	Magnet	Plastic
13	Hexagon screw	Carbon steel
14	Cushion pad	TPU
15	Rear cover	Aluminum alloy
16	Bolt	Carbon steel

Main Dimension

FVBC

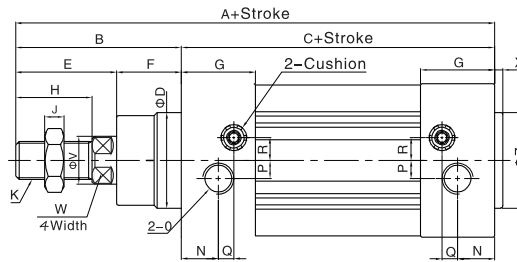
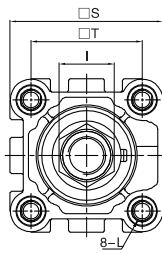

Bore/Sign	A	B	C	D	E	F	G	H	I	J	K	L	N	O	P	Q	R	S	T	V	W	X	Z
32	142	48	94	30	29	19	27.5	22	17	6	M10x1.25	M6 Dp.16	13	1/8"	5.5	6	6	46.5	32.5	12	10	3	30
40	159	54	105	35	33	21	32	24	17	7	M12x1.25	M6 Dp.16	17	1/4"	6	7.5	8.5	54	38	16	13	3.5	35
50	175	69	106	40	42	27	31	32	23	8	M16x1.5	M8 Dp.16	15.5	1/4"	7.5	6.5	9.5	64	46.5	20	17	3.5	40
63	190	69	121	45	42	27	33	32	23	8	M16x1.5	M8 Dp.16	16.5	3/8"	7.5	7.5	11.5	75	56.5	20	17	4	45
80	214	86	128	45	53	33	33	40	26	10	M20x1.5	M10 Dp.17	16.5	3/8"	8	8.5	12.5	93	72	25	22	4	45
100	229	91	138	55	55	36	37	40	26	10	M20x1.5	M10 Dp.17	19.5	1/2"	10	7	12	110	89	25	22	4	55

Note: With magnet and without magnet, the dimensions are same.

FVBCD

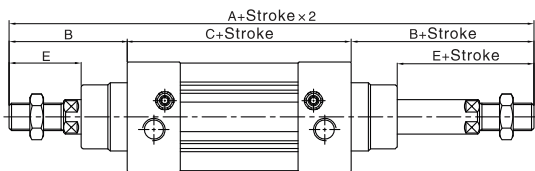

Bore/Sign	A	A1	B	C	E	Z	J	K
32	190	188	48	94	29	27	6	M10x1.25
40	213	208	54	105	33	28	7	M12x1.25
50	244	233	69	106	42	31	8	M16x1.5
63	259	248	69	121	42	31	8	M16x1.5
80	300	286	86	128	53	39	10	M20x1.5
100	320	304	91	138	55	39	10	M20x1.5

FVBCJ

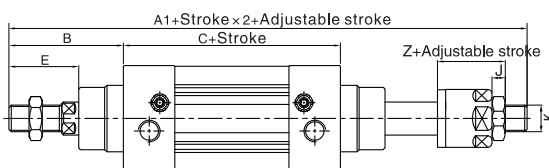

Note: 1. With magnet and no magnet, the dimensions are same.
2. Not marked dimension is same as FVBC standard type.
3. FXBC series dimensions is same as FVBC.

Dimension of Mounting Accessories

◎LB



Bore/Sign	AA	AC	AD	AE	AF	AG	AH	AP	AT
FJ-VBC32LB	158	142	8	47	32	24	32	7	4
FJ-VBC40LB	179	161	9	53	36	28	36	9	4
FJ-VBC50LB	190	170	10	65	45	32	45	9	5
FJ-VBC63LB	209	185	12	75	50	32	50	9	5
FJ-VBC80LB	248	210	19	95	63	41	63	12.5	6
FJ-VBC100LB	258	220	19	115	75	41	71	14.5	6

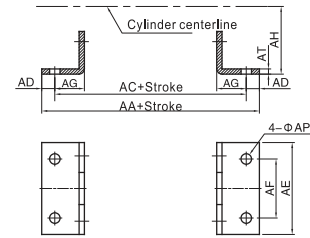

◎FA/FB



Bore/Sign	AJ	AK	BA	BB	BC	BD	BE	BF	BH	BP	T
FJ-VBC32FA	11	7	30.5	10	47	32	80	64	6	7	32.5
FJ-VBC40FA	11	7	35.5	10	53	36	90	72	6	9	38
FJ-VBC50FA	14	9	40.5	12	65	45	110	90	8	9	46.5
FJ-VBC63FA	14	9	45.5	12	75	50	125	100	8	9	56.5
FJ-VBC80FA	17	11	45.5	16	95	63	154	126	10	12.5	72
FJ-VBC100FA	17	11	55.5	16	115	75	186	150	10	14.5	89

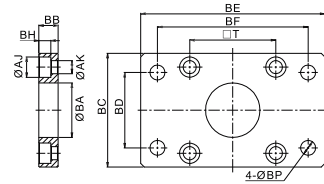

◎CA



Bore/Sign	DA	DC	DE	DJ	DP	DQ	DZ	S	T
FJ-VBC32CA	31	22	10	9.5	7	25.8	5.5	47	32.5
FJ-VBC40CA	37	25	12	9.5	7	27.8	5.5	53	38
FJ-VBC50CA	39	27	12	10.5	9	31.8	6.5	65	46.5
FJ-VBC63CA	47	32	16	10.5	9	39.7	6.5	75	56.5
FJ-VBC80CA	51	36	16	14.5	11	49.7	10	95	72
FJ-VBC100CA	61	41	20	14.5	11	59.7	10	115	89

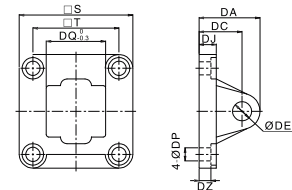

◎CB



Bore/Sign	DA	DC	DE	DJ	DP	DQ	DT	DZ	S	T
FJ-VBC32CB	31	22	10	9.5	7	26 ^{+0.52} ₀	45	5.5	47	32.5
FJ-VBC40CB	37	25	12	9.5	7	28 ^{+0.52} ₀	52	5.5	53	38
FJ-VBC50CB	39	27	12	10.5	9	32 ^{+0.62} ₀	60	6.5	65	46.5
FJ-VBC63CB	47	32	16	10.5	9	40 ^{+0.62} ₀	70	6.5	75	56.5
FJ-VBC80CB	51	36	16	14.5	11	50 ^{+0.62} ₀	90	10	95	72
FJ-VBC100CB	61	41	20	14.5	11	60 ^{+0.74} ₀	110	10	115	89

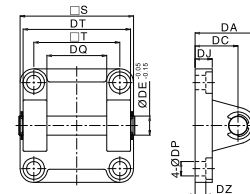

◎CR



Bore/Sign	DC	DD	DE	DF	DJ	DP	DQ	DM	DN	S	T
FJ-VBC32CR	32	10	10	21	8	7	25.8	31	18	51	38
FJ-VBC40CR	36	11	12	24	10	7	27.8	35	22	54	41
FJ-VBC50CR	45	13	12	33	12	9	31.8	45	30	65	50
FJ-VBC63CR	50	15	16	37	12	9	39.7	50	35	67	52
FJ-VBC80CR	63	15	16	47	14	11	49.7	60	40	86	66
FJ-VBC100CR	71	19	20	55	15	11	59.7	70	50	96	76

