

# IA/IAC Series ISO6432 Mini Type Cylinder



## IA/IAC

### Mini Type Cylinder



### Specifications

Bore size(mm)	8	10	12	16	20	25
Acting type	Double Acting/Single Acting					
Working medium	Clean Air(40 μ m filtration)					
Working pressure (MPa)	0.1~0.7(Double Acting) / 0.2~0.7(Single Acting)			0.1~1.0(Double Acting) / 0.2~1.0(Single Acting)		
Guaranteed pressure (MPa)	1.5					
Working temperature (°C)	-20~80(No freezing)					
Speed range (mm/s)	Double Acting: 30~800			Single Acting:50~800		
Cushion type	Rubber cushion			Rubber cushion(Standard) / Air cushion(Optional)		
Barrel material	Stainless steel					
Mounting type	LB FA SDB					
Port size	M5 x 0.8			G1/8①		

① PT、NPT port size is optional.

### How to Order?

Series No	Cushion Type	Type No	Bore	X	Stroke	Adjustable Stroke	Magnet No	Tail Type	Mounting Type	Thread Type				
IA: Stainless steel barrel	C: Air Cushion	Blank: Basic type D: Double shaft type J: Double shaft and adjustable stroke type SA: Single action extend type SB: Single action return type	8	...	25	10	Blank: No Magnet S: With Magnet	Blank: Swiveling tail U: Flat tail CM: Round tail	Blank: No LB FA SDB TC IJ YJ BJ ....	Blank: G P: PT T: NPT				
	Blank: Rubber Cushion		10		50	20					12	50	16	75
			12		75	30					20	75	25	40
			16		...	40					50	75	100	
			20											
			25											

#### Order Example:

IA series, Double shaft and adjustable stroke type, air cushion, bore 20mm, stroke 25mm, adjustable stroke 20, with magnet, no mounting type, round tail, PT thread.  
ERP code is: IACJ20\*25-20-S-CM-P

Note: 1.If cylinder with several different mounting accessories, please use this sequential coding: LB/FA/SDB /IJ/YJ/BJ

- IA Series, Bore 8mm and Bore 10mm, No round tail type is optional.
- IAC Series, Φ16、Φ20、Φ25 is optional.

### Optional Accessories

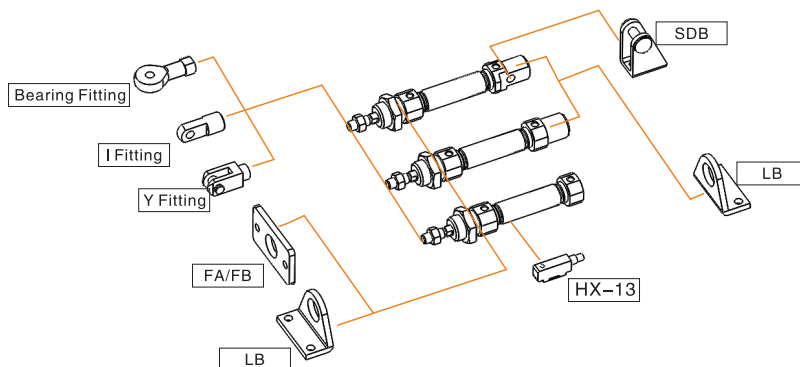

## ◎ Stroke

Bore (mm)	Standard Stroke (mm)	Max. Stroke (mm)	
Double Acting	8	25 50 75 100 125 150	200
	10	25 50 75 100 125 150 175 200	200
	12	25 50 75 100 125 150 175 200 225 250	500
	16	25 50 75 100 125 150 175 200 225 250 300 350 400 500	500
	20-25	25 50 75 100 125 150 175 200 225 250 300 350 400 500	800
Single Acting	8	10 15 20 25 30 40 50	50
	10	10 15 20 25 30 40 50	50
	12	10 15 20 25 30 40 50	50
	16	10 15 20 25 30 40 50 60 75 80 100	100
	20-25	10 15 20 25 30 40 50 60 75 80 100 125 150	150

## ◎ Internal Structure

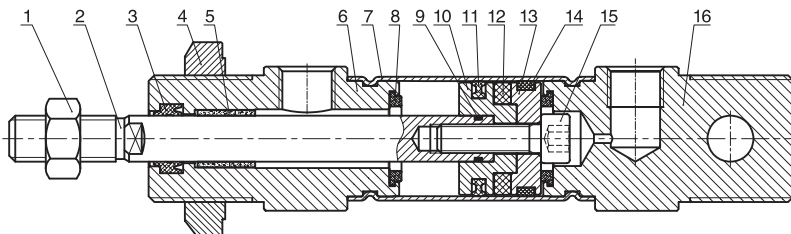

NO.	Part name	Material
1	Nut	Carbon steel
2	Piston rod	IA8, 10: SUS304 hard chrome carbon steel / IA12-IA25: S45C hard chrome carbon steel
3	Piston rod seal	NBR
4	Nut	Carbon steel
5	Self lubricating bearing	Bronze powder
6	Head cover	Aluminum alloy
7	Barrel	Stainless Steel
8	Anti-bump cushion	TPU
9	O-ring	NBR
10	Piston	IA8, 10: Stainless steel / IA12-IA25: Aluminum alloy
11	Piston seal	NBR
12	Magnet	Plastic
13	Magnet base	IA8, 10: Stainless steel / IA12-IA25: Aluminum alloy
14	Wear ring	PTFE
15	Hexagon screw	Carbon steel
16	Rear cover	Aluminum alloy

# IA/IAC Series ISO6432 Mini Type Cylinder



## Main Dimension

### IA $\Phi 8-\Phi 25$

#### CA Type

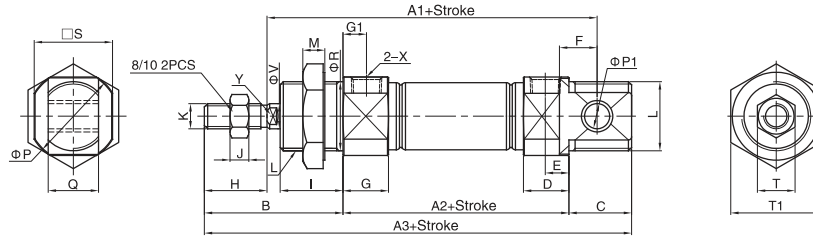

#### CM Type

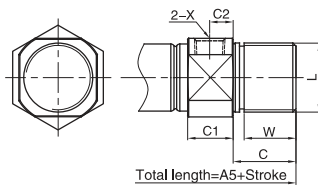

#### U Type

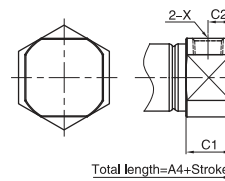

Bore/Sign	(mm)																								
	A1	A2	A3	A4	A5	B	C	C1	C2	D	E	F	G	G1	H	I	J	K	L	M	P	P1	Q	R	S
8	64	46	86	74	-	28	12	9.5	5	9.5	5.2	6	11.5	7	12	12	3	M4X0.7	M12X1.25	7	17	4	8	12	15
10	64	46	86	74	-	28	12	9.5	5	9.5	5.2	6	11.5	7	12	12	3	M4X0.7	M12X1.25	7	17	4	8	12	15
12	75	50	105	88	105	38	17	10	5	10	5	9	12	7	16	17	5	M6X1.0	M16X1.5	6	19.7	6	12	16	18.3
16	82	56	111	94	111	38	17	10.5	5.5	10.5	5.5	9	12.5	7	16	17	5	M6X1.0	M16X1.5	6	22	6	12	16	20
20	95	62	126	106	126	44	20	14.5	7.5	14.5	7.5	12	14.5	7.5	20	20	6	M8X1.25	M22X1.5	7	29	8	16	22	25
25	104	65	137	115	137	50	22	16	8	16	8	12	16	8	22	22	6	M10X1.25	M22X1.5	7	33.5	8	16	22	30

Bore/Sign	T	T1	X	V	W	Y
8	7	17	M5X0.8	4	-	-
10	7	17	M5X0.8	4	-	-
12	10	22	M5X0.8	6	15	5
16	10	22	M5X0.8	6	15	5
20	12	29	1/8"	8	18	6
25	17	29	1/8"	10	20	8

Note: With magnet and no magnet, the dimensions are same.

### IAD $\Phi 8-\Phi 25$

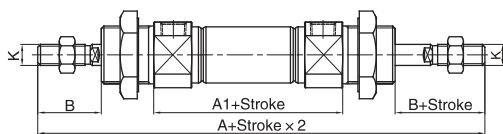

### IAJ $\Phi 8-\Phi 25$

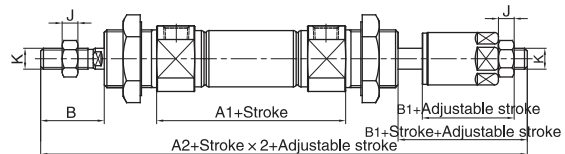

Bore/Sign	A	A1	A2	B	B1	J	K
8	104	48	103.5	16	15.5	3	M4X0.7
10	104	48	103.5	16	15.5	3	M4X0.7
12	128	52	128	21	21	5	M6X1.0
16	134	58	134	21	21	5	M6X1.0
20	150	62	151	24	25	6	M8X1.25
25	165	65	164	28	27	6	M10X1.25

Note: Unlabeled the same size as standard type.

## ◎ Main Dimension

### IAC $\Phi 16-\Phi 25$

#### CA Type

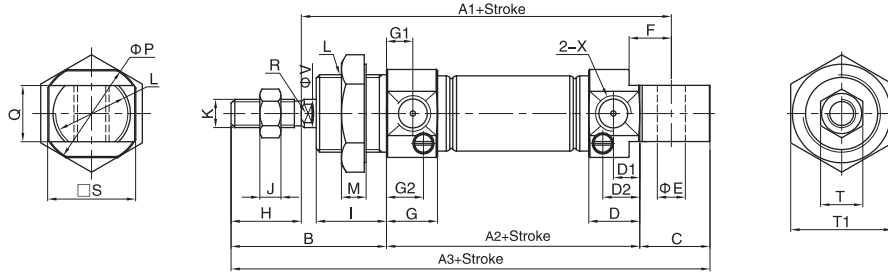

#### CM Type

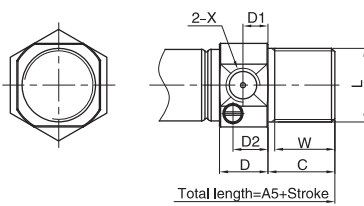

#### U Type

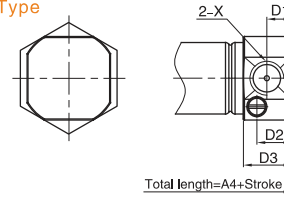

(mm)

Bore:Sign	A1	A2	A3	A4	A5	B	C	D	D1	D2	D3	E	F	G	G1	G2	H	I	J	K	L	M	P	Q	R
16	82	56	111	94	111	38	17	12	6	9	12	6	9	12.5	7	9.5	16	17	5	M6X1.0	M16X1.5	6	22	12	5
20	95	62	126	106	126	44	20	14.5	7.5	11	14.5	8	12	14.5	7.5	11	20	20	6	M8X1.25	M22X1.5	7	29	16	6
25	104	65	137	115	137	50	22	16	8	12.5	16	8	12	16	8	12.5	22	22	6	M10X1.25	M22X1.5	7	33.5	16	8

Bore:Sign	S	T	T1	X	V	W
16	20	10	22	M5X0.8	6	15
20	25	12	29	1/8"	8	18
25	30	17	29	1/8"	10	20

Note: With magnet and no magnet, the dimensions are same.

### IACD $\Phi 16-\Phi 25$

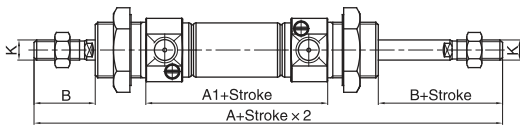

### IACJ $\Phi 16-\Phi 25$

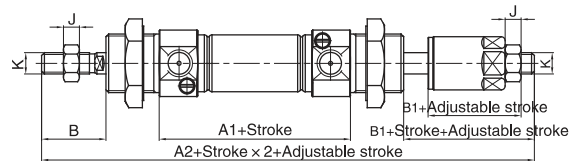

Bore:Sign	A	A1	A2	B	B1	J	K
16	132.5	56.5	132.5	21	21	5	M6X1.0
20	150	62	151	24	25	6	M8X1.25
25	165	65	164	28	27	6	M10X1.25

Note: Unlabeled the same size as standard type.

# IA/IAC Series ISO6432 Mini Type Cylinder



## Main Dimension

### IASB $\Phi 12-\Phi 25$

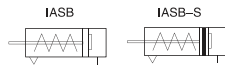

#### CA Type

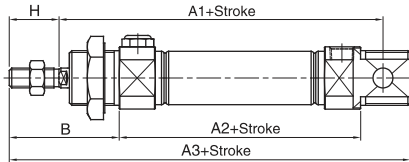

#### CM Type

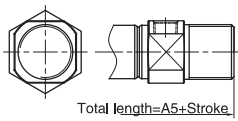

Total length=A5+Stroke

#### U Type

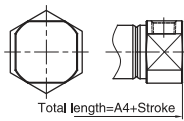

Total length=A4+Stroke

### IASA $\Phi 12-\Phi 25$

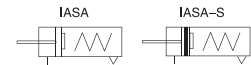

#### CA Type

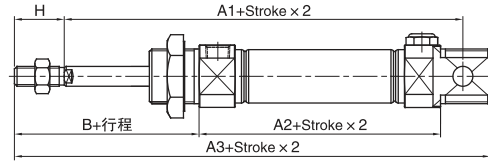

#### CM Type

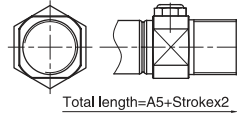

Total length=A5+Strokex2

#### U Type

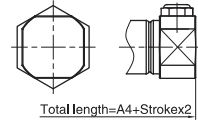

Total length=A4+Strokex2

Bore\Sign	A1			A2			A3			A4			A5			B	H
	0-50	51-100	101-150	0-50	51-100	101-150	0-50	51-100	101-150	0-50	51-100	101-150	0-50	51-100	101-150		
12	100	-	-	75	-	-	130	-	-	113	-	-	130	-	-	38	16
16	107	132	-	81	106	-	136	161	-	119	144	-	136	161	-	38	16
20	120	145	170	87	112	137	151	176	201	131	156	181	151	176	201	44	20
25	129	154	179	90	115	140	162	187	212	140	165	190	162	187	212	50	22

Note: Unlabeled the same size as standard type.

## Accessory Dimensions

### LB Accessory

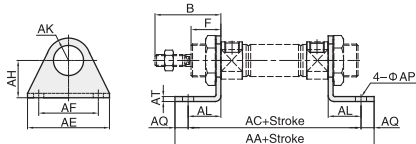

Model\Sign	AA	AC	AE	AF	AH	AK	AL	AP	AQ	AT	B	F
FJ-IA12LB	88	76	42	32	20.5	12.5	13	6	6	4	38	17
FJ-IA16LB	94	82	42	32	20.5	12.5	13	6	6	4	38	17
FJ-IA20LB	114	98	54	40	22.5	20	18	7	8	4	44	20
FJ-IA25LB	117	101	54	40	22.5	20	18	7	8	4	50	22

### FA Accessory

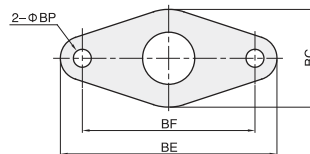
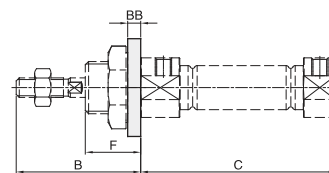

Model\Sign	B	C	BB	BC	BE	BF	F
FJ-IA12FA	38	50	4	30	53	40	17
FJ-IA16FA	38	56	4	30	53	40	17
FJ-IA20FA	44	62	5	40	66	50	20
FJ-IA25FA	50	65	5	40	66	50	22

### SDB Accessory

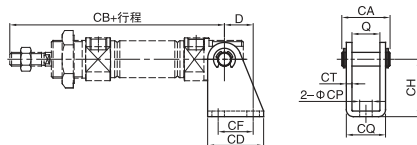

Model\Sign	D	Q	CA	CB	CD	CF	CH	CP	CQ	CT
FJ-IA12SDB	13	12.1	21.5	91	25	15	27	5.5	17.1	2.5
FJ-IA16SDB	13	12.1	21.5	98	25	15	27	5.5	17.1	2.5
FJ-IA20SDB	16	16.1	29	115	32	20	30	6.6	24.1	4
FJ-IA25SDB	16	16.1	29	126	32	20	30	6.6	24.1	4